

Haven Seajack 2



Type of vessel:	Modular Jack Up Barge
Length o.a.:	18 m
Breadth o.a.:	12 m
Depth o.a. Hull:	1.52 m
Deck Area	224 m ²
Max Leg Length:	27 m
Leg Diameter:	0.76 m
Single Jack Capacity	80 Tonnes
Jacking Stroke	1.5 m
Average Jacking Speed	15 m/hour
Gross Tonnage:	52.53 GT
Lightship Weight:	190 Tonnes
Allowable Deck Load:	80 Tonnes
Allowable Deck Point Load:	6 Tonnes/m ²
Certification:	Certificate of British Registry MCA Workboat Certificate Life Raft Certificate of Inspection Certificate of survey Ofcom Ship Radio Licence
Standard Equipment:	Cabin Mess Room, Workshop, Fuel Bowser, Navigation Shapes and Lights, Bollards, Handrails
Optional Equipment:	Access Walkways, Moon Pool, Winches, Cantilever Ladder Platforms, Generators, Knuckle Boom Cranes.



RED7MARINE
MARINE CONSTRUCTION
DIVING AND SUBSEA

RED7MARINE LTD
SHORE FARM
WRABNESS
MANNINGTREE
CO11 2TG

Tel: +44 (0)1255 886710
Fax: +44 (0)1255 886658
Email: enquiries@r7m.co.uk
Web: www.red7marine.co.uk

Haven Seajack 2

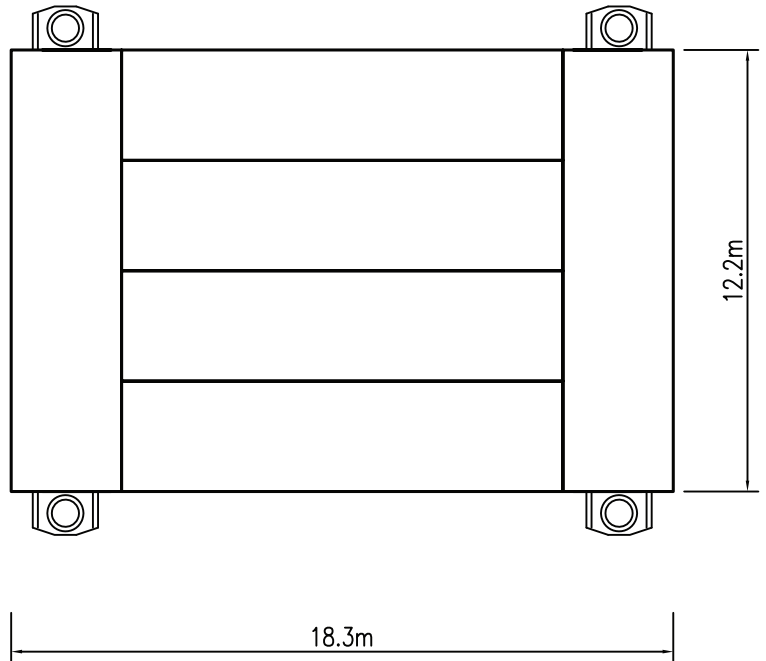

Plan View

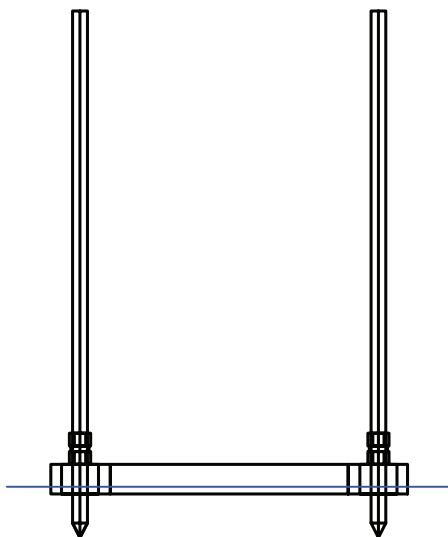

Elevation of Floating Platform

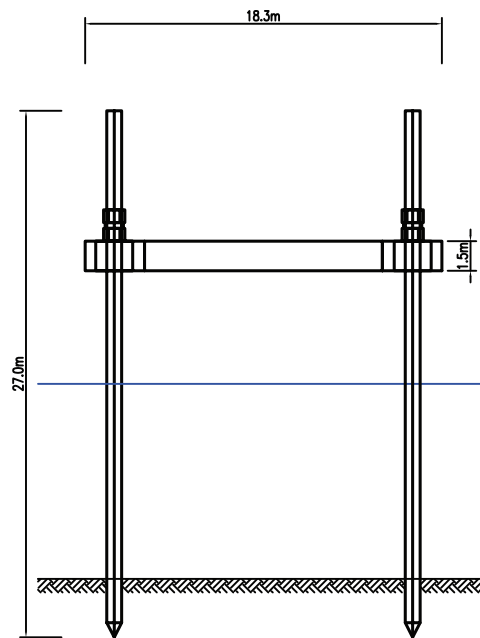

Elevation of Jacked-up Platform



RED7MARINE
MARINE CONSTRUCTION
DIVING AND SUBSEA

RED7MARINE LTD
SHORE FARM
WRABNESS
MANNINGTREE
CO11 2TG

Tel: +44 (0)1255 886710
Fax: +44 (0)1255 886658
Email: enquiries@r7m.co.uk
Web: www.red7marine.co.uk